



DEGSON ELECTRONICS CO., LTD.

Product Specification

CE



HT396R-3.96

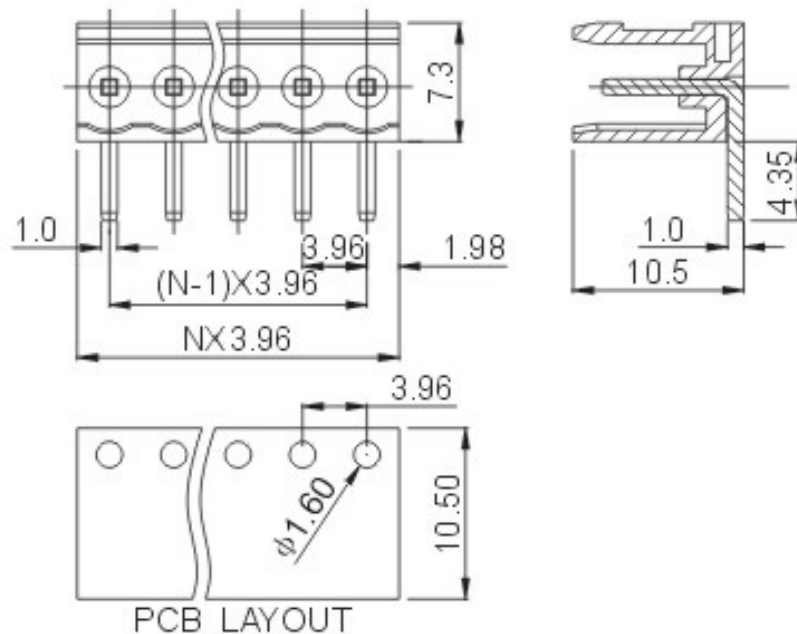

Approval	CE	
Electrical		
Standard	UL	IEC
Rated voltage	150V	250V
Rated current	8A	15A
With standing voltage	AC2000V/1Min	
Mechanical		
Ambient temperature	-40°C~+105°C	
Dimensions		
Pitch	3.96mm(.156")	
Poles	2P-24P	
Material		
Housing	PA66, UL94V-0	
Pin header	Brass, Tin plated	

HOW TO ORDER

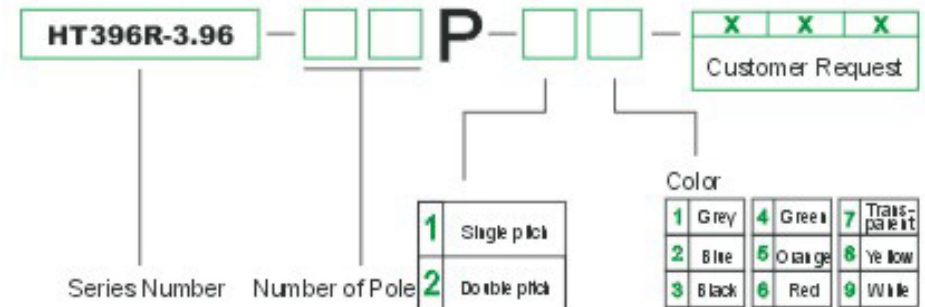

	DEGSON ELECTRONICS CO., LTD.
	NAME HT396R-3.96